

7. The Trouble Shooting

Please read the user's manual carefully before using the DVD player. If you have any problems with this product please refer to the below Trouble shooting guide to help you resolve the issue.

NO PICTURE, SOUND AND INDICATION

- * Ensure that the power switch is on.
- * Ensure that the wall inlet is ok.
- * Ensure that the power cord is not damaged or the fuse is not blown.
- * Ensure that the power plug is connected to the inlet tightly.

NO SOUND BUT PICTURE OK

- * Ensure that the player's audio output has a good connection with TV's audio input.
- * Check whether the audio connector is damaged.
- * Check whether you have turned down the volume.
- * Ensure that you have set the right AUDIO setup of the player.
- * Ensure that the audio is not under mute.

NO PICTURE BUT SOUND OK

- * Ensure that the player's video output has a good connection with TV's video input.
- * Ensure that you have turned your TV to the AV input channel connecting to your player.
- * Check whether the video connector is damaged.
- * Ensure that you have set the right VIDEO settings of the player.

BLACK AND WHITE PICTURE OR SCREEN ROLLING

- * Ensure that you have set the right TV SYSTEM (e.g. PAL, NTSC) setting.

FLAWS OF PICTURE OR SOUND

- * Check whether the setting of AUDIO is right.
- * Check whether the disc is scratched or stained.
- * Check whether the AV connector and the output terminal is stained.
- * Check whether there is condensation inside the Lens. If so, leave the player off for an hour or so, then try again.
- * Check whether the installation angle is less than 30.

DISPLAY NO DISC OR BAD DISC

- * Ensure that you have put the disc on the tray.
- * Check whether the disc is put in the reverse side.
- * Check whether the disc is distorted.
- * Check whether the disc is stained or scratched badly.
- * Ensure that the disc format is compatible to the player.
- * Ensure that the temperature inside the car is not too high. If so, cool off until the ambient temperature returns to normal.
- * Replace another disc to insert it into the disc compartment.

REMOTE CONTROL IS INSENSITIVE OR DOES NOT WORK

- * Check the batteries of remote control and make sure that they are not flat.
- * Direct the remote control to the IR sensor of the player.
- * Check whether there are some obstacles between the remote control and IR sensor.

SOME FUNCTION BUTTONS DO NOT WORK

- * Turn off the power, then turn on again.
- * Reset the unit to zero, then turn on again.
- * Remove the front panel from the unit, then install it again and then turn on again.

THE RADIO DOES NOT WORK

- * Check whether the antenna cable is connected firmly. Or manually tune for a station.

STEREO FUNCTIONS LOCK UP or BLUE TOOTH FUNCTION IS NOT RESPONDING TO DEVICE

- * Use a metal pin to press the software reset button in the recess hole on the front of the stereo.

Contents

1. Before Operation.....	3
1.1 Feature.....	3
1.2 Precautions.....	3
1.3 Maintenance and Cleaning of Discs.....	4
1.4 Battery Information of the Remote Control.....	4
1.5 The Remote Control Description.....	5
1.6 Locations and Names of the Controls.....	6
1.7 Wiring Diagram.....	11
1.8 Mounting Installation.....	14
2. Common Operation.....	15
3. Radio Operation.....	17
4. Basic Disc, USB Operation.....	18
4.1 Begin Playback.....	18
4.2 Pause Playback.....	19
4.3 Stop Playback.....	19
4.4 Select Chapter/Track with the the >> / << Buttons.....	19
4.5 Select Chapter/Track with the Number Buttons.....	19
4.6 Select Chapter/Track with the Root/PBC Menu.....	19
4.7 Terminate the Playback.....	20
5. Advanced Disc, USB Operation.....	20
5.1 Playback with Speed.....	20
5.2 Playback with Slow Speed.....	20
5.3 Playback with Still Frame.....	21
5.4 Playback Repeatedly.....	21
5.4.1 One/All Repeat.....	21
5.4.2 A-B Repeat.....	21
5.5 Playback from a specified Chapter/Track or a Specified Time.....	22
5.6 Playback in Random.....	22
5.7 Playback in Different Angle.....	22
5.8 Playback in Zoom Mode.....	22
5.9 Change the Caption Language.....	23
5.10 Change the Audio Language.....	23
5.11 Look over the Playback Status.....	23
5.12 Program Playback.....	24
5.13 Playback the Picture CD in JPEG Format.....	24
5.14 MP4 Operation.....	25
5.15 ESP and ID3 Function.....	25
5.16 USB Operation.....	25
5.17 The DVD System Menu Setup Operation.....	25
5.18 The Parental Control.....	29
5.19 The Region Code.....	30
6. Bluetooth Handfree System.....	31
APP CONTROL.....	33
7. The Trouble Shooting.....	34
8. Specification.....	35

1. Before Operation

Thank you for purchasing a Furrion Product, we hope you will enjoy using our product. For maximum enjoyment please look through the following manual to learn about all the features of your Furrion Stereo.

1.1 Features:

- Digital AM / FM Tuner
- DVD/CD-R/RW/MP3/MP4/WMA Compatible
- Bluetooth with NFC function
- Auxiliary inputs on front and rear
- USB input with charging function
- 2 zone multi room audio output
- 1 x HDMI output with ARC function
- 2 x RCA audio/video outputs for connecting 2 additional TVs
- 1 x subwoofer output
- Clock

1.2 Precautions

Ensure to connect this product to a 12V DC negative ground battery system which is standard in North America, Europe and Australia Vehicles.

Ensure when installing the Stereo all wire ends which are not being used are terminated with an insulated end to avoid wires shorting or earthing which can lead to the risk of fire or electrical shock.

Avoid inserting foreign objects into the disk loading slot of the Stereo as this will cause malfunction.

Do not expose this product in moist or wet environments, if condensation is present in the screen, wait for 1 hour or more for the moisture to evaporate. If the interior of the vehicle is extremely hot, do not use the player until the vehicle internal temperature has cooled down.

Do not use cleaning products on the front face of the product, only use a slightly damp cloth for cleaning.

Do not attempt to disassemble or adjust this product, contact a service center for assistance.



AUX



ARC



DVD/CD



USB



BT

1.3 Maintenance and Cleaning of Discs

Disc Maintenance

1. To keep the disc clean, handle the disc by its edge, do not touch the disc surface of the play side.
2. Do not stick paper or tape on the disc. If there is glue (or analog) on the disc surface, must wipe it off before using.
3. Do not expose the disc to direct sunlight, or nearby heat sources such as caliduct, or leave it in a car parked in direct sunlight where there can be a considerable rise in temperature.
4. Put the disc inside disc case to keep temperature after finishing playback.

Disc Cleaning

1. Before playing, wipe the disc with a clean lint. wipe the disc outwards from the disc center.
2. Do not use petrol, thinners, commercially available cleaners or anti-static sprays for plastic LP's to wipe discs.

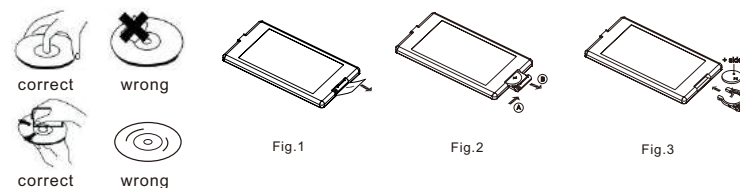

1.4 Battery Information of the Remote Control

Replace Battery in the Remote Control:

1. Before using the remote control for the first time, pull the insulating sheet out of the remote control as the direction indicated by the arrow. (see fig.1)
2. Press the movable block hold as the direction indicated by the A arrow (See fig.2), then pull the battery holder out of the remote control as the direction indicated by the B arrow (see fig.2).
3. Replace the old battery by a new battery with (+) polarity side upward. (See fig.3).
4. Insert the battery holder to the original position in remote control. (See fig.3).

Note about the Battery of the Remote Control:

1. Improper use of battery may cause overheating or explosion, so that result in injury or fire.
2. Battery leakage may cause damage to the remote control (Battery Life: 6 months with normal use in normal room temperature).
3. Do not short the battery.
4. Do not throw the battery into the fire.
5. To avoid the risk of accident, keep the battery out of reach of children.

1.5 The Remote Control Description

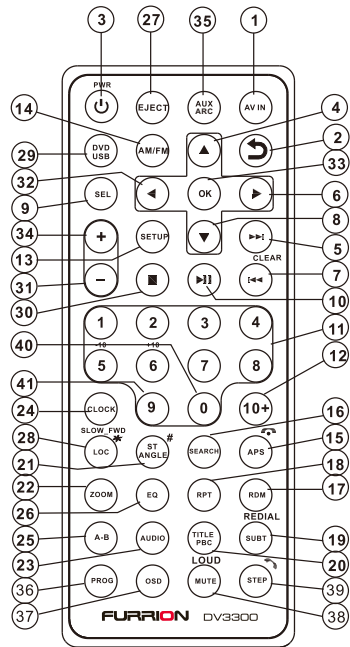

16. SEARCH BUTTON
17. RANDOM BUTTON
18. REPEAT BUTTON
19. SUBTITLE/REDIAL BUTTON
20. TITLE/PBC BUTTON
21. ST/ANGEL/# BUTTON
22. ZOOM BUTTON
23. AUDIO BUTTON
24. CLOCK BUTTON
25. A-B BUTTON
26. EQ BUTTON
27. EJECT BUTTON
28. LOC/SLOW-FWD/* BUTTON

1. AV IN MODE BUTTON
2. BACK BUTTON
3. POWER BUTTON
4. UP BUTTON
5. NEXT BUTTON
6. RIGHT BUTTON
7. PREVIOUS BUTTON/CLEAR BUTTON
8. DOWN BUTTON
9. SEL BUTTON
10. PLAY/PAUSE BUTTON
11. NUMBER(0~9, +10 -10) BUTTONS
12. 10+ BUTTON
13. SETUP BUTTON
14. AM/FM RADIO MODE BUTTON
15. APS/HAND UP BUTTON
29. DVD/USB MODE BUTTON
30. STOP BUTTON
31. VOLUME- BUTTON
32. LEFT BUTTON
33. OK BUTTON
34. VOLUME+ BUTTON
35. AUX/ARC MODE BUTTON
36. PROGRAM BUTTON
37. OSD BUTTON
38. MUTE/LOUD BUTTON
39. STEP/TEL BUTTON

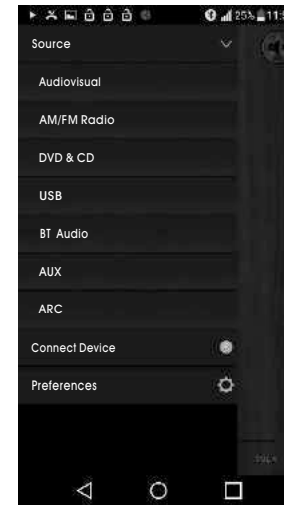

SOURCE

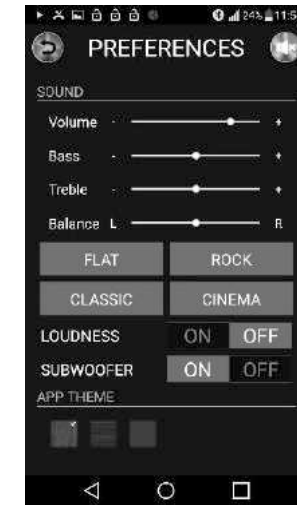

Preferences



RADIO

APP CONTROL (support both iOS and Android system):

1. APP Installation.

Another way to control the unit instead of using the front panel or remote control, you can use your smartphone. You will need to install the "ES Control" app onto your mobile device. The app will need to be downloaded from Google Play (Android smartphone) or App Store (iPhone). Do a search for "ES Control" and proceed to download. Install per the app instructions.

2. Turn on the BT function of your smartphone and pair with Dv3300.

3. Under BT connection, tap the "ES Control" icon to enter the APP connection interface, then select the name "FURRION DV3300-XXXX" (Android smartphone) or "DV3300-4.0-XXXX" (iPhone) to enter it. (where X can be any character A-Z or number 0-9)

4. Use the APP to control the DV3300 freely.

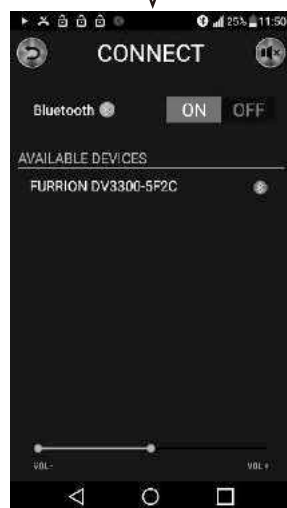

CONNECT



Audiovisual

1.6 Locations and Names of the Controls

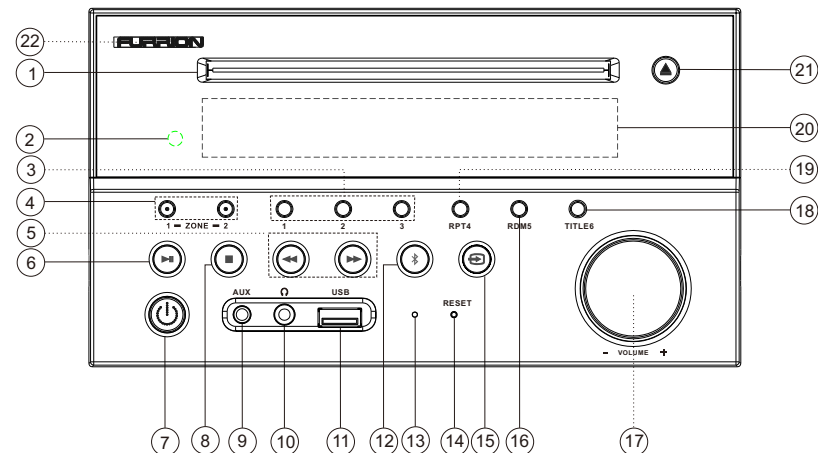

- | | |
|---|-----------------------------------|
| 1. DISC SLOT | 10. HEADPHONE SOCKET |
| 2. IR REMOTE CONTROL SENSOR | 11. USB SOCKET |
| 3. 1/2/3 BUTTON
1 TEL /REDIAL BUTTON
2 HANG UP BUTTON | 12. BT MODE BUTTON/EQ BUTTON |
| 4. ZONE 1/2 BUTTON | 13. MICROPHONE IN |
| 5. << / >> BUTTON | 14. RESET BUTTON |
| 6. PLAY/PAUSE BUTTON
RADIO REGION SELECT BUTTON | 15. INPUT MODE BUTTON/BAND BUTTON |
| 7. POWER BUTTON | 16. 5/RANDOM BUTTON |
| 8. STOP BUTTON
AS/PS BUTTON | 17. VOL KNOB/SEL BUTTON |
| 9. AUX IN SOCKET | 18. 6/TITLE BUTTON |
| | 19. 4/REPEAT BUTTON |
| | 20. LCD DISPLAY |
| | 21. EJECT BUTTON |
| | 22. NFC DETECTION AREA |

Description of icons on the LCD display

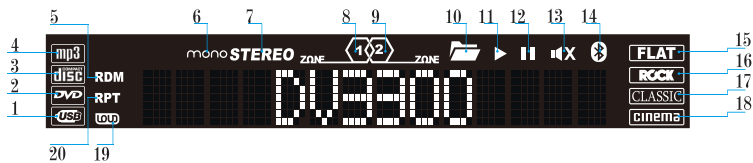

1. USB icon
After inserting a USB storage, USB icon is lit.
2. DVD icon
After inserting a DVD disc, DVD icon is lit.
3. DISC icon
After inserting a disc(DVD,VCD,CD), DISC icon is lit.
4. MP3 icon
If a disc or a USB storage contains MP3 format files, MP3 icon is lit.
5. RDM icon
In random playback mode, RDM icon is lit.
6. MONO icon
In mono audio mode, MONO icon is lit.
7. STEREO
In stereo audio mode, STEREO icon is lit.
8. ZONE <1> icon
When selecting the ZONE 1 speakers, ZONE <1> icon is lit.
9. ZONE <2> icon
When selecting the ZONE 2 speakers, ZONE <2> icon is lit.
10. FOLDER icon
If a USB storage contains more than 2 folders(contains playback file), FOLDER icon is lit.
11. PLAYBACK icon
During disc or USB playback state, PLAYBACK icon is lit.
12. PAUSE icon
During disc or USB pause playback state, PAUSE icon is lit.
13. MUTE icon
When the Stereo is on mute state, MUTE icon is lit.
14. BLUETOOTH icon
When the Stereo is paired and connected successfully, BLUETOOTH icon is lit.
15. FLAT icon
When selecting flat audio mode playback, FLAT icon is lit.
16. ROCK icon
When selecting rock audio mode playback, ROCK icon is lit.
17. CLASSIC icon
When selecting classic audio mode playback, CLASSIC icon is lit.
18. CINEMA icon
When selecting cinema audio mode playback, CINEMA icon is lit.
19. LOUD icon
When selecting loud audio mode playback, LOUD icon is lit.
20. RPT icon
In repeat playback mode, RPT icon is lit.

4.3 To redial the last phone number dialed

- (1) Short press **TEL** button on the remote control or **1** button on the front panel, it will show last phone number on the LCD, then it will execute the dialing.
- (2) Short press **REDIAL** button on the remote control, it will dial the last phone number.

5. Accept/Reject/End Call

- 5.1 Incoming call ringing, short press **TEL** button on the remote control or **1** button on the front panel to accept the call.
- 5.2 To reject Incoming call ringing, short press **HANG UP** button on the remote control or **2** button on the front panel to REJECT the call.
- 5.3 During a phone call, short press **HANG UP** button on the remote control or **2** button on the front panel to end the call.

Note: When an incoming call is present the caller's phone number will be displayed on the screen.

6. To play an audio file from an external Bluetooth device(mobile phone) on the wall mount Stereo

After the device has been paired successfully and Wall mount Stereo screen displays LINK OK

If your mobile device supports A2DP you will then be able to stream music from your Bluetooth device so it can be played by stereo speaker. You must select on your mobile Bluetooth device to play the audio through Bluetooth. If your mobile device supports AVRCP then you will be able to control the basic phone audio output functions by the Wall mount Stereo controls. Eg. Play Pause.

Note: During other modes(except Bluetooth conversation), press **BT MODE** button on the front panel to switch the mode with others.

7. To setup your Stereo using NFC(only support mobile phone with NFC function)

- (1) Turn on the NFC function of your mobile phone and make sure the screen is active and unlocked.
- (2) With the NFC detection area of your phone touch with the NFC detection area of the Stereo, you can connect or disconnect your mobile phone with the Stereo conveniently.

Note: For the first time pair and connect, it will ask you to input a password. The password is "0000".

6. BLUETOOTH HANDFREE SYSTEM

1. Pairing and connection

- 1) Turn on the Bluetooth mode of the mobile phone;
- 2) Select the item of Finding the Bluetooth Device and enter it. After finishing the finding, it will show the name of the Bluetooth Device **FURRIION DV3300-XXXX** (where **X** can be any character **A-Z** or number **0-9**). Select it and enter it, then it will show an interface that ask you to input a password, input the password 0000 and enter it. Then it will tell you pair OK.
- 3) For some mobile phones, they can automatically connect with the BT device of the car audio system after pairing is ok; for some mobile phones, they need to select the paired BT device and press the CONNECTION button. When connection is ok, the LCD of the car audio system will show LINK OK.

2. Use the mobile phone to do connection or disconnection

In the connection status, find the paired and connected Bluetooth Device, then press the disconnection button to do disconnection.

In the disconnection status, find the paired and disconnected Bluetooth Device, then press the connection button to do connection.

3. In the connection status: Mobile phone transfers to the car audio whenever a dialling takes place; mobile phone transfers to the car audio whenever receiving a call.

Note: Press **BT MODE** button on the front panel to switch between Unit and Phone during BT phone conversation.

4. Dialling when in connection status

4.1 Dial with the mobile phone directly.

4.2 Dial with remote control with the following procedures:

- (1) Input telephone number with number buttons 0-9

* Short press **CLEAR** button to cancel the wrongly input number if necessary

- (2) Short press **TEL** button to execute the dialing.

QUICK REFERENCE GUIDE

General Operation

Power On/Off STANDBY	Press POWER to turn the unit on or enter standby mode. Long press POWER to turn the unit off.
Mute	Press MUTE button on the remote control to mute the audio, "MUTE" icon will flash in the display. Press MUTE again to cancel.
Selecting a Source	Press INPUT MODE button repeatedly to select Tuner, Disc (After inserting a disc), USB (After inserting a USB storage), BT, ARC AV IN and AUX mode.
Volume Adjust	Rotating VOL KNOB to adjust volume.
Audio Adjustment	Press VOL KNOB to select between VOL, BAS (without EQ preset), TRE (without EQ preset), BAL and BEEP. Rotate it to select audio feature.
Preset EQ Curves	Press EQ button to select between CINEMA, ROCK CLASSIC, FLAT.
CLOCK SET	Press and hold CLOCK button on the remote control to enter CLOCK Setup, rotate VOL KNOB to adjust hour. Press it briefly to minute setting and rotate it to adjust. Once time is set, the unit will automatically set after a few seconds.
LOUD ON/OFF	Press and hold LOUD button on the remote control to turn on or off LOUD mode.
SPEAKER SELECTION	Press ZONE 1 or 2 button to select speaker output, "ZONE <1>" or "ZONE <2>" will display on the LCD once it is selected.
RESET	Press RESET with a cuspidal object to make the unit be reset to factory default and re-instate the correct functions.

Radio Operation

Area Frequency Selection	Press and hold PLAY/PAUSE button for 5 seconds to set AM/FM radio region(Europe/USA1/USA2/AUST-RALIA)
Manual Tuning	Press ◀◀ or ▶▶ button to move radio frequency down or up one step at a time.
Seek Tuning	Press and hold ◀◀ or ▶▶ button to search the next strongest station automatically.
Band	Press and hold INPUT MODE button on the front panel or briefly press AM/FM button on the remote control to select between FM1,FM2,FM3,AM1,AM2.
Storing and Recalling Station Presets	Press and hold any one of the six preset button(1-6) to store the current frequency. Press the corresponding preset button to recall the frequency stored.
Automatically Store Stations	Press and hold APS button on the remote control or press and hold ■ button on the front panel to automatically store the six strongest station in the current band.(Up to18 FM stations and 12 AM stations can be stored)
Scan Tuning	Briefly Press APS button on the remote control or press ■ button on the front panel to scan presets 1-6 in the current band.
LOC	Press LOC button on the remote control to turn on/off LOC.
Stereo/Mono	In FM mode,press ST button on the remote control to select the Stereo or Mono sound mode.

5.19 The Region Code

Q: No DVD playback. Screen displays REGION ERROR after inserting disc into disc compartment. Why ?

A: Because the DVD player and disc have different region codes. If they do not match, the DVD player cannot play the disc.

Appendix: The region code of DVD:

The Motion Picture Association of America (MPAA) divided the world into 6 regions, and named every region a code, namely region code. The region codes and the countries or areas represented by the region codes are as follows:

- Region 1: America, Canada, East-Pacific Inlands;
- Region 2: Japan, West Europe, North Europe, Egypt, South Africa, Middle East;
- Region 3: South-east Asian countries include Taiwan, Hong Kong, South Korea, Thailand, Indonesia, etc.;
- Region 4: Australia, New Zealand, Central South America, South Pacific Inlands;
- Region 5: Russia, Mongolia, Indian Peninsula, Middle Asia, East Europe, North Korea, North Africa, North-west Asia etc.;
- Region 6: China mainland.

Supported Video Format					
File Extension	Container	Video Codec	Audio Codec	Resolution	Remark
.avi .divx	AVI	MPEG-4 Visual DivX 4.xx/5.xx/6.xx/3ivX XviD MPEG-1	Dolby Digital (AC3) WMA/PCM/LPCM AAC-LC (2ch) MPEG-Audio (MP1/MP2/MP3)	720 x 480 (30fps) 720 x 576 (30fps)	
.mpg	MPG	MPEG-1/MPEG-2	Dolby Digital (AC3) LPCM MPEG-Audio (MP1/MP2/MP3)	720 x 480 (30fps) 720 x 576 (30fps)	
.dat	DAT	MPEG-1/MPEG-2	Dolby Digital (AC3) LPCM MPEG-Audio (MP1/MP2/MP3)	720 x 480 (30fps) 720 x 576 (30fps)	
.vob	VOB	MPEG-1/MPEG-2	Dolby Digital (AC3)	720 x 480 (30fps) 720 x 576 (30fps)	
.mp4	MP4	MPEG-4 Visual	Dolby Digital (AC3) WMA/LPCM AAC-LC (2ch) MPEG-Audio (MP1/MP2/MP3)	720 x 480 (30fps) 720 x 576 (30fps)	
Supported Audio Format					
File Extension	Audio Codec	Bit Rate	Sampling Rate	Remark	
.mp3	MP3	16kbps - 320kbps	8k - 48kHz		
.wma	WMA	16kbps - 320kbps	8k - 48kHz	WMA only support WMA7/WMA8/WMA9 (CBR/VBR) (only support 353 format)	

Note: Reading the above file formats is not guaranteed.

5.18 The Parental Control

Q: After inserting DVD disc into disc compartment, a dialogue window will appear asking for a password of 4 digits. Why ?

A: This is because that the disc movie you are playing was rated with the Parental Control, and the current rating level of DVD player is lower than one of current disc. You must input right password and enter it to entry Parental Control setup menu and then set a equal or higher rating level than one of current disc. So that you can playback the disc.

! NOTE

- * If you have not changed the password, the factory preset password for the DVD player will be empty. So that you should input a desired password and input it again to verify it to enter the Parental Control setup menu.
- * For the rating level setup of Parental Control of the DVD player, please refer to the relative content of SYSTEM SETUP menu for details.

Accessories: Parental Control

The Parental Control function of a DVD player can control the playback of movie rated level in a disc. Can set the DVD player(include software player in PC) to be a certain rating level with SETUP MENU on TV screen. If the rating level set in the disc is higher than one set in the DVD player, the DVD player can not playback the disc. Sometimes the Parental Control sequences in some discs are different from each other. The rating level setup can be protected by the password. Therein, if you select Unlock item, the Parental Control function will be invalid, the content of disc will be played totally.

The disc movie can be designed as that the DVD player will playback the different version of content of a same movie according to the different rating level set by Parental Control. Depend on the DVD feature of seamless switching described above, the scenes that are not fitting for children will be cleared or replaced by the other fitting scene automatically.



All rating levels of Parental Control are as follows:

	Unlock
1	Kid Safe
2	G
3	PG
4	PG 13
5	PG R
6	R
7	NC 17
8	Adult

Disc USB Operation

Insert Disc	With the label facing up, insert a disc into the disc slot. The disc will automatically begin playback.
Eject Disc	Press EJECT to eject the disc.
Track Select	Press ◀◀ or ▶▶ button to move to previous or next track/chapter.
Fast Forward and Backward	Press and hold ◀◀ or ▶▶ button to fast backwards or forward.
Pause Playback	Press ▶ to temporarily stop the playback. Press ▶ again to resume playback.
Stop Playback	Press ■ once to pause the playback, press ▶ to resume; press ■ twice to stop playback, then press ▶ to start playback from the beginning of the first chapter/track.
Repeat	Press RPT to repeat current playing track/chapter. Press RPT to resume.
Random	Press RDM to play each track in random order. Press RDM again to resume.
Title	In DVD/VCD mode, press TITLE on the remote control to display the title list.

BLUETOOTH OPERATION

Dial or Accept Call	Press the 1 button on the front panel to accept, dial or redial a call. Press  to accept, dial or redial a call.
Reject or End Call	Press the 2 button on the front panel to reject or end a call. Press  to reject or end a call.

1.7 Wiring Diagram

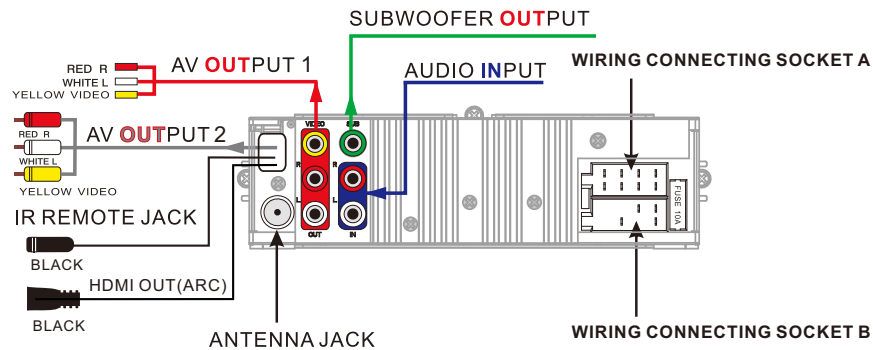

The Description of the Wiring Diagram for Socket A and Socket B

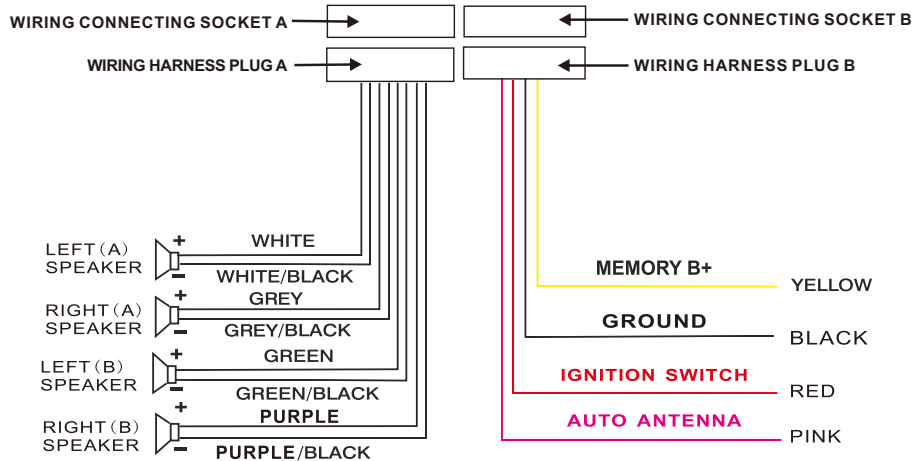

CONTRAST

It is for adjusting the contrast of the video output

HUE

It is for adjusting the hue of the video output.

SATURATION

It is for adjusting the saturation of the video output.

SHARPNESS

It is for adjusting the sharpness of the video output.

5.17.5 SPEAKER SETUP



DOWNMIX

It is for selecting your desired sound effect when there is no center speaker and subwoofer. There are 3 modes: LT/RT, STEREO, VSS.

LT/RT: When playing a disc with PRO LOGIC Dolby stereo effect, choose the item, so it will output audio signal with vivid theater effect.

STEREO: If you choose the item, when outputting audio signal with 5.1 channels, it will output the left and right channels of signal; when outputting audio signal with 2 channels, it will output the common 2 channels of stereo signal.

VSS: If you choose the item, when playing a disc recorded with 5.1 channels, the main channel speakers can output audio signal with VSS effect.

5.17.6 DIGITAL SETUP

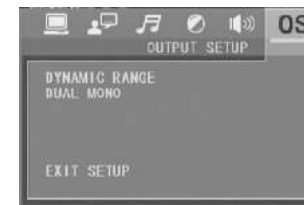

DYNAMIC RANGE

After selecting the compression mode of LINE OUT, set the item, so you can adjust the linear compression ratio. If you set it to be FULL, the Peak-to-Peak value of the audio signal is the minimum; if you set it to be OFF, the Peak-to-Peak value is the maximum.

DUAL MONO

It is for selecting a desired audio output mode for the left and right ways of signal. It is mainly for Karaoke of Ac3. There are 4 modes in all as follows: STEREO, MONO L, MONO R, MIX MONO.

5.17.2 LANGUAGE SETUP

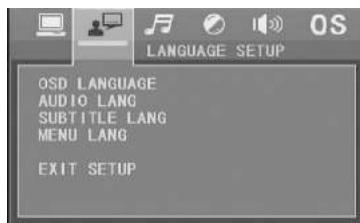

OSD LANGUAGE

This item is for selecting the language of the SYSTEM MENU and all operating prompt interface displayed during playback.

AUDIO LANG

This item is for selecting an audio language.

SUBTITLE LANG

This item is for selecting a subtitle language.

MENU LANG

This item is for selecting a disc menu language.

5.17.3 AUDIO SETUP

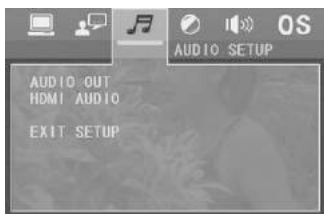

AUDIO OUT:

For the selection of Digital output method. SPD IF/OFF ,SPD IF /RAW,SPD IF/PCM.

HDMI AUDIO:

AUTO: Selected to output the audio automatically by RAW or PCM type.

PCM: Selected to output the audio by PCM type..

5.17.4 VIDEO SETUP

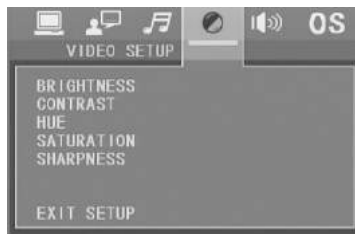

BRIGHTNESS

It is for adjusting the brightness of the video output.

WIRING CONNECTING SOCKET A VIEW

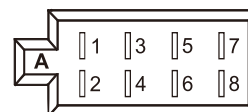

PIN NO	COLOR	FUNCTION
1	PURPLE	RIGHT (B) SPEAKER (+)
2	PURPLE/BLACK	RIGHT (B) SPEAKER (-)
3	GREY	RIGHT (A) SPEAKER (+)
4	GREY/BLACK	RIGHT (A) SPEAKER (-)
5	WHITE	LEFT (A) SPEAKER (+)
6	WHITE/BLACK	LEFT (A) SPEAKER (-)
7	GREEN	LEFT (B) SPEAKER (+)
8	GREEN/BLACK	LEFT (B) SPEAKER (-)

WIRING CONNECTING SOCKET B VIEW

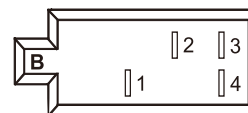

PIN NO	COLOR	FUNCTION
1	YELLOW	+12V DC MEMORY B+
2	PINK	AUTO ANTENNA
3	RED	+12V DC IGNITION SWITCH
4	BLACK	POWER GROUND(-12DC)

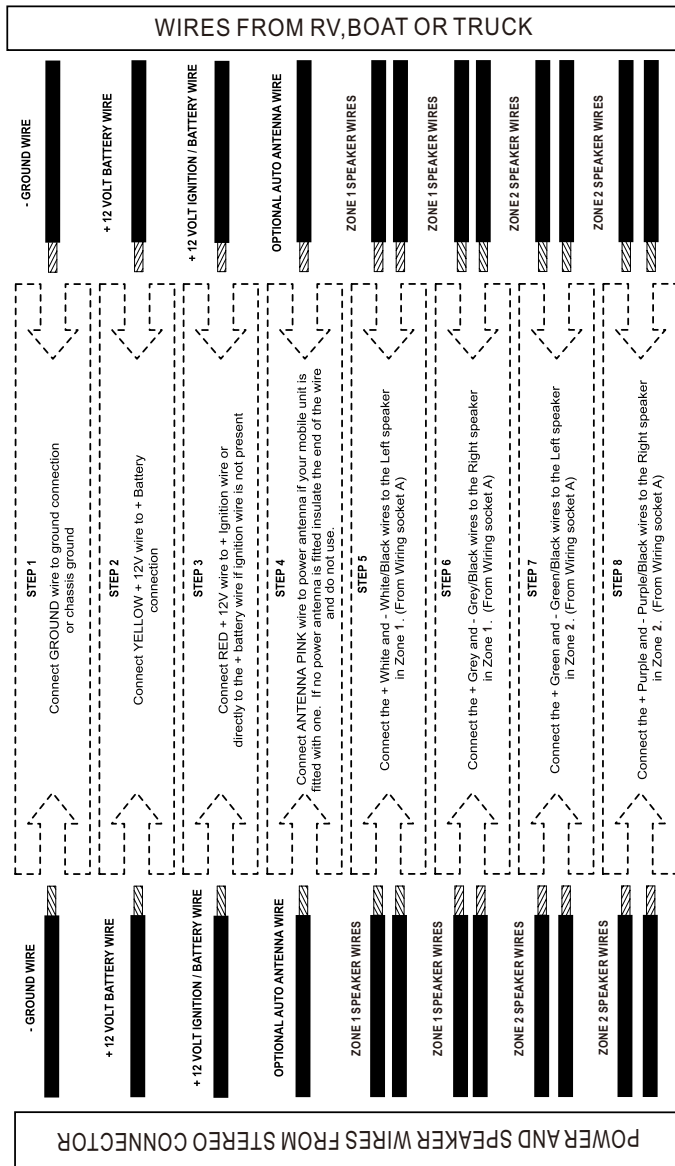

For the DVD System Menu, there are 6 setup pages in all. They display as follows:

5.17.1 SYSTEM SETUP

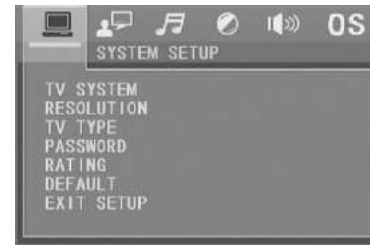

TV SYSTEM

The Stereo supports output of various TV system. If your TV has only NTSC or PAL system, the screen will blink and become colorless when a wrong TV system is selected. In this case go to TV SYSTEM and select NTSC, PAL or AUTO to match the system of your TV.

RESOLUTION

The setup is for resolution level selection.

TV TYPE

The setup item is for matching TV screen size.

4:3 PS: Choose the item when connecting a TV set with 4:3 screen. When playing the pictures with 16:9 size, the left and right parts of the video will be cut out, and display in full screen.

4:3 LB: Choose the item when connecting a TV set with 4:3 screen. When playing the pictures with 16:9 size, the top and bottom parts of the TV screen will be turned into a black square respectively.

16:9: Choose the item when connecting a TV set with 16:9 wide screen.

PASSWORD

This setup item is for locking or unlocking the rating level of the Parental Control. The defaulted state is locked. The defaulted password is 0000.

You can set a new password that you like: Select the PASSWORD item and then press the > button to enter it, then input the original password 0000, and then press the OK button to unlock it. Press the > button to enter it again, then input a new password that you like and then press the OK button to make it effective. Before the other persons see the Manual, you should get the password in mind and cut out the part of PASSWORD in the Manual.

RATING

The item is for setting a new rating level of the Parental Control.

1. Select the PASSWORD item and then press the > button to enter it, then input the password mentioned above, and then press the OK button to unlock the setting of the rating level of the Parental Control.
2. Select the RATING item and then press the > button to enter it, then use the direction buttons to select your desired rating level, then press the OK button to confirm.
3. Select the PASSWORD item again and then press the > button to enter it, then input the password, and then press the OK button to lock the new setting of the rating level of the Parental Control.

DEFAULT

This item is for making all setup items change back to original status.

3. During JPEG playback, press one of the direction buttons to change the angle of viewing picture that is displaying as follows:
>: 90 deg cw; <: 90deg ccw; ^:UP<-->DOWN; v: LEFT<-->RIGHT
During JPEG playback, press **PROG** button on the remote control to change the mode of refresh picture. During JPEG playback, press **STOP** button to stop playing and return to the root menu.
- * During JPEG playback, the following buttons are not available: **SLOW-FWD**, **SUBT**, **TITLE/PBC**, **ANGLE**, **STEP**, **AUDIO**, **RDM** and **A-B**.
- * In JPEG mode, the other operations are same as ones in MP3/WMA mode.

5.14 MP4 Operation

1. The root menu is displayed on TV when beginning to switch on DISC mode, then it will automatically play the first file.
During playback, press **STOP** button to stop playing and return to the root menu.
2. When displaying the root menu, press the direction buttons to select your desired FOLDER or file, then press **OK** or **PLAY/PAUSE** ►|| button to open the FOLDER, or play the selected file.
When displaying the root menu, you can also use the number buttons to select the serial number of the file and play the file.
- * **ANGLE**, **PROG**, **RDM**, and **TITLE/PBC** buttons are not valid.
- * The other functions are same as ones in DVD disc; but the "Repeat" function is same as one in MP3/WMA.

5.15 ESP and ID3 Function

There is ESP function for all formats of discs.

In MP3/WMA mode, during playback, the information of the file name, folder name, song s title, artist and album will be scrolling on the LCD display. As long as the current playing MP3 music contains relevant ID3 tag information in version 1.0/2.0 format, the 3 items underlined above will be scrolling on the LCD display; otherwise, they will not.

5.16 USB Operation

Power on the DVD player, then insert the USB storage, then the monitor will display the root menu of the USB storage
This device support picture(JPG format), audio(MP3 or WMA format) and Video (MP4 format), all the operations are same as ones of the corresponding format.

NOTE: 1.Playback file format is not guaranteed.

2.The USB input with charging function (not all products can be charged from the unit)

5.17 The DVD System Menu Setup Operation

1. Press **SETUP** button on the remote control to access the DVD System Menu on the monitor.
2. There are 6 setup pages in all for the System Menu. Press the > or < button to select an desired setup page.
3. Press the ^ or v button to select an setup item in the selected setup page.
4. Press the > button to enter the setup item. Then press the v or ^ button to select a desired mode of the setup item, finally press **OK** button to confirm it.
- * Press the < button to return to the upper level.
- * Press **SETUP** button on the remote control again or use the direction buttons to highlight the item of the **EXIT SETUP** and then press **OK** button to exit the System Menu.

1.8 Mounting Installation

Location

- * Choose a mounting location away from humid areas, water sources, appliances or any equipment that can radiate heat.
- * Select an area on a wall or cabinet which is free from cable, fuel or brake lines and ensure the area behind the wall mount stereo has a vent hole or if it is an enclosed box and has adequate room around the rear of the unit for cooling.
- * Ensure when the stereo is mounted in the cut out that the wires at the rear of the unit are not pressed against the heat sink

Installing the unit.

- * Before finally installing the unit, connect the wiring temporarily and make sure the unit and the system work properly.
- * Fix the unit with screw according to following diagram.

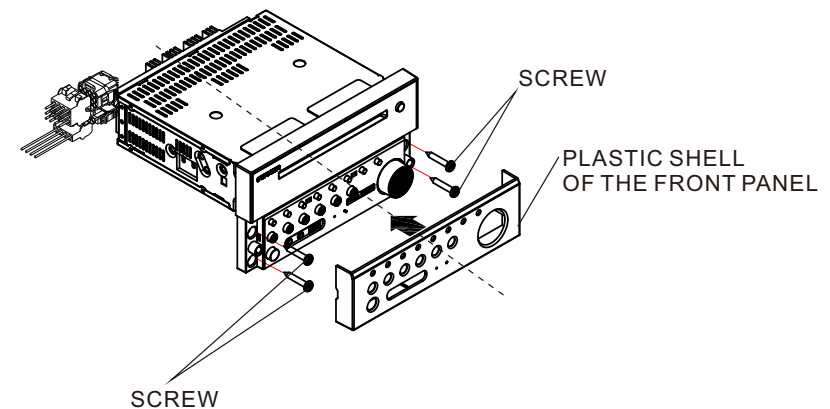

1. Remove plastic shell of the front panel from the unit.
2. Fix the unit with 4 pieces #8 pan head self tapping screw.
3. Put back plastic shell of the front panel to the unit.

2. Common Operation

1. Turning On and Off the unit

By pressing the power button will turn on or enter standby mode

2. Selecting a Source:

1) Use **INPUT MODE** button on the front panel.

Press **INPUT MODE** button repeatedly to select Tuner, Disc (After inserting a disc), USB (After inserting a USB storage), BT, ARC, AV IN and AUX mode.

Note: By pressing **BT** button to enter into the Bluetooth mode directly. Press again to back to current playback mode.

2) Use the corresponding buttons on the remote control.

DVD / USB - once a DVD or USB is inserted into the unit, the unit will automatically switch to display this source menu. Press this function button on the remote control to select DVD if a disk is already inserted and the unit is playing from another source.

AM/FM - by pressing this button on the remote control will scroll through the FM1, FM2, FM3, AM1, AM2. To switch this unit's AM/FM receiver between USA and Europe frequencies press and hold **PLAY/PAUSE** button on the front panel for 5 seconds until the region is displayed on the screen.

AUX/ARC - by pressing this button on the remote control allow you to scroll through the AUX /ARC inputs fitted to the stereo.

AUX - connection on the front of the unit (Audio and Video input function)

ARC - connection a TV with Audio Return Channel function to the HDMI Output Jack on the rear of the unit. (Make sure the ARC function of the TV is ON)

*For details on settings and operating your TV, refer to the instruction manual for the TV.

*About Audio Return Channel (ARC)

ARC allows audio signals to travel both ways under HDMI Control. If you connect a TV that supports HDMI Control and ARC to the unit with a single HDMI cable, you can output video/audio to the TV or input TV audio to the unit.

In case noises are produced from the speakers connected to the unit because TV audio signals input to the unit via ARC are not supported by the unit, use the TV's speakers.

AV IN - connection on the rear of the unit to connect an external audio source.

3. Volume Adjust

Rotate **VOLUME KNOB** clockwise to increase volume, rotate anticlockwise to reduce volume.

5.12 Program Playback

It allows you to enter the order in which you want some chapters/tracks in DVD/VCD/MP3/WMA/CD disc to play.

1 During playback, press **PROG** button on the remote control to enter a program interface as follows:

For DVD discs /MP3/WMA



For VCD/CD discs



- 2 Use the direction buttons to move cursor onto the desired place for inputting the sequence number.
- 3 Use the number button to input desired sequence number of title/chapter/track with desired sequence.
- 4 Use the direction button to move cursor onto **PLAY**, then press **OK** button on the remote control to play the programmed titles/chapters/tracks in programmed order; only pressing **PLAY/PAUSE** button also can play the programmed titles/chapters/tracks in programmed order.

- * To exit program playback, firstly press **STOP** button, then press **PLAY/PAUSE** button to enter sequence playback; or press **PROG** button twice again.
- * To remove the all programmed sequence numbers, move the cursor onto **CLEAR**, then press **OK** button on the remote control.
- * To change the programmed sequence, move the cursor onto the item you want to change, input the desired sequence number.
- * During VCD playback, if it is in PBC ON mode, at the same time of entering the state of program playback, it turns off PBC mode.

5.13 Playback the Picture CD in JPEG Format

1. The root menu is displayed on the monitor when beginning to switch on DISC mode. At the time, it plays MP3/WMA file. (**TITLE** or **PBC** button is not available).
In the root menu, the left file sort icon is for MP3/WMA file; the middle file sort icon is for VIDEO file; the right file sort icon is for JPEG file. If one of these 3 file sort does not exist, you can not move cursor onto the file sort icon.
2. When displaying the root menu, press the direction buttons to select your desired FOLDER, file or file sort icon, then press **OK** or **PLAY/PAUSE** button to open the FOLDER, or play the selected file, or play only this sort of file. When displaying the root menu, you can also use the number buttons to select the serial number of the file and play the file.
When you select a JPEG file sort icon, press one of the direction buttons to select the first JPEG file, then press the v button to select the desired JPEG file, finally press **OK** or **PLAY/PAUSE** button to display the JPEG picture in full screen from the selected JPEG picture.

ZOOMx2,ZOOMx3,ZOOMx4,ZOOMx1/2,ZOOMx1/3,ZOOMx1/4,ZOOM OFF.
Press one of the direction buttons to select the area you want to enlarge.

5.9 Change the Caption Language

When playing DVD discs, press **SUBT** button on the remote control repeatedly to select the language of the caption or turn off the caption.(depend on the disc used.)

When playing VCD/MP3/WMA/CD discs, the button is not available.

5.10 Change the Audio Language

1. When playing DVD discs, press **AUDIO** button on the remote control repeatedly to select the desired language type(depend on the disc used)
2. When playing VCD discs, press **AUDIO** button on the remote control repeatedly to select the sound mode of the MONO L, MONO R, and Stereo, no language function.
3. When playing CD/WMA/MP3 discs, **AUDIO** on the remote control button is invalid.

5.11 Look over the Playback Status

1. When playing DVD discs, press **OSD** button on the remote control repeatedly to turn on/off the playback status. When it is on, it will display the information such as: the serial number of the playing title, the serial number of the playing chapter, the elapsed time of the playing chapter, the remaining time of the playing chapter, the elapsed time of the playing title, the remaining time of the playing title, etc.
2. When playing VCD/CD discs, press **OSD** button on the remote control repeatedly to turn on/off the playback status. When it is on, it will display the information such as: the serial number of the playing track, the elapsed time of the playing track, the remaining time of the playing track, the elapsed time of the disc, the remaining time of the disc.

4. Mute

Press **MUTE** button to mute what ever source is playing and display mute on the screen.
Press **MUTE** button again to release unit from mute.

5. Clock Set

1) To display the clock on the LCD display, press **CLOCK** button on the remote control
2) To adjust or set the clock, press and hold **CLOCK** button on the remote control until the clock set feature is displayed on the LCD display of the stereo then use **VOLUME KNOB** on the unit or **+** and **-** on the remote control to adjust the time, push in the volume knob on the stereo or press **SEL** button on the remote control to change from setting hours to minutes. Once time is set the stereo will automatically set after a few seconds if not pressing any functions.

6. To select a preset EQ mode

Press and hold **BT** button on the front panel or briefly press **EQ** button on the remote control to select the preset music equalizer curves: CINEMA, ROCK, CLASSIC, FLAT. The sound effect will be changed.

7. To turn on/off LOUD mode

Press and hold **LOUD** button on the remote control to turn on/off LOUD mode.

8.To adjust the sound equalizer curves

To adjust the sound equalizer curves, briefly and repeatedly press **SEL** button on the remote control to select the sound equalizer curves of VOL, BAS(without preset EQ), TRE (without preset EQ), BAL,BEEP(ON/OFF), then rotate the **VOL KNOB** on the front panel or press the **+** and **-** on the remote control to adjust level.

9.ZONE 1/2 BUTTON

Pressing **ZONE 1** or **2** button will turn on or off the audio source in each of the different areas which your speakers are connected. "ZONE <1>" or "ZONE <2>" will display on the LCD once it is selected.

10.Press the **↶** button or **TITLE** button up to the previous menu.

11.To reset the unit

When the display is incorrect, or the function buttons are not effective or sound is distorted, then use a sharp point to press **RESET** button, that will make the unit be reset to factory default and re-instate the correct functions.

3. Radio Operation

1. FREQUENCY SELECT

In RADIO mode, Press and hold **PLAY/PAUSE** ►|| button for about 5 seconds to select your desired frequency EUROPE,USA1,USA2 or AUSTRALIA.

2. AM/FM BUTTON

In RADIO mode, press and hold **INPUT MODE** button on the front panel or briefly press **AM/FM** button on the remote control to select your desired radio band of FM1, FM2, FM3, AM1, AM2, and the selected band will be displayed on the LCD of the front panel.

3. TUNE/SEEK UP/DOWN

In RADIO mode:

- 1) Press and hold ◀◀ or ▶▶ button on the front panel or Press and hold ◀◀ / ▶▶ button on the remote control to automatically search down/up for a available station from the current frequency.
 - 2) Press ◀◀ or ▶▶ button on the front panel or press ◀◀ / ▶▶ button on the remote control to manually search up or down with step by step for your desired station from the current frequency.
- #### 4. APS BUTTON
- In RADIO mode:
- 1) When pressing and holding **APS** button on the remote control or press and hold ■ button on the front panel, the radio searches from the lowest frequency and checks the signal strength level until 1 cycle search is finished. And then the 6 strongest stations are preset to the corresponding preset number memory bank. The AS operation is implemented in each bank of the selected band. When the AS operation is finished, it will resume broadcasting on the M1. (It can store 3x6 stations for FM and 2x6 stations for AM in all)
 - 2) When briefly pressing **APS** button on the remote control or press ■ button on the front panel, the radio searches for each preset station from the M1. When the field strength level is more than the threshold level of the stop level, the radio holds at that preset number for a few seconds with releasing mute, and then searches again. After finishing a circle of searching, it will stop searching on the M1.

NOTE: In FM band, FM1,FM2,FM3 is checked one at a time.
In AM band, AM1, AM2 is checked one at a time.

5. PRESET STATION [1-6] BUTTONS

In RADIO mode:

- 1) To memorize the current frequency on the current band, press and hold any one of the six preset buttons (1-6).
- 2) To recall the preset memory on the current band, press one of the preset buttons [1-6].

6. STEREO/MONO BUTTON

Press **ST** button on the remote control to select the STEREO or MONO sound mode for FM band.

7. LOC BUTTON

- 1) In RADIO mode, when the signal of the distance radio station are very weak and the receiving effect is bad during tuning, press **LOC** button on the remote control to turn off the LOC function, then tune again for the distance radio station;
- 2) In RADIO mode, when the signals from the local radio stations are too strong, this could lead to interference. press **LOC** button on the remote control to turn on the LOC function, Re-tune for the local station required.

5.5 Playback from a specified chapter/track or a specified time

1. When playing DVD discs, press **SEARCH** button on the remote control to display an interface and highlight the title item, then use the number buttons to input the serial number of the title; use the direction buttons to highlight the chapter item, then use the number buttons to input the serial number of the chapter; finally press **OK** or **PLAY/PAUSE** ►|| button to play the selected chapter.
2. When playing VCD/MP3/WMA/CD discs, press **SEARCH** button on the remote control to display an interface and highlight the track item, then use the number buttons to input the serial number of the track; finally press **OK** or **PLAY/PAUSE** ►|| button to play the selected track.

5.6 Playback in Random

When playing DVD/VCD(PBC OFF)/MP3/WMA/CD discs, press **RDM** button to switch between RANDOM ON /RANDOM OFF. When in RANDOM ON mode, it will play in random.

5.7 Playback in Different Angle

1. When playing VCD/MP3/WMA/CD discs, **ANGLE** button on the remote control is not available.
2. When playing DVD discs, press **ANGLE** button on the remote control repeatedly to view in different angle. (This function is only for the DVD discs with ANGLE function)

5.8 Playback in Zoom Mode

In DVD/VCD mode, during playback, press **ZOOM** button on the remote control repeatedly to enlarge a certain area of the images on the screen with these multiples:

During slow forward, press **PLAY/PAUSE** ►|| button to resume normal playback.

The function is only for video.

5.3. Playback with still frame

If the unit is currently running DVD.VCD disc, press **STEP** button on the remote control consecutively to display the still frame forward with step by step. Press **PLAY/PAUSE** ►|| button to resume normal playback.

5.4 Playback Repeatedly

5.4.1 ONE/ALL Repeat

1. In the mode of DVD disc playback:
Press **RPT** button to select REP CHAPTER, REP TITLE, REP ALL or REP OFF.
2. In the mode of VCD(PBC OFF)/CD disc playback:
press **RPT** button to select REP ONE, REP ALL or OFF.

When it is in the state of PBC ON, during VCD disc playing, the **RPT** button is not available.

3. In the mode of MP3/WMA disc playback:
Press **RPT** button to select REP ONE, REP DIR, REP ALL or OFF.

5.4.2 A-B Repeat

Press **A-B** button on the remote control if you want to repeat a specific segment on a disc that you define:

1. Press **A-B** button at a point (A) where you want it to be the start point of the repeat segment. Press **A-B** button again at a point (B) where you want it to be the terminal point of the repeat segment. Then it will play the segment repeatedly.
2. To cancel A-B repeat mode and resume normal playback, press **A-B** button for the third time.

Note:

During DVD/VCD/MP3/WMA/CD playback, points A and B must be within the same track.

4 Basic Disc USB Operation

4.1 Begin playback

1. Press **POWER** button briefly to turn on the DVD player.

After turning on the DVD player, please turn on the monitor, and ensure that the video output of the monitor is the video input from the DVD player connected with the monitor.

? Common Question

Q: There is not anything is displayed on TV screen when the DVD player is turned on. How to solve the problem?

A: Ensure that the TV was set to right video input(not TV channel); for example, if you make VIDEO1 INPUT of TV and DVD player connected with each other, then you need set TV to VIDEO1.

2. Insert a disc into the **DISC SLOT**(Label surface up).

! NOTE

1. For some discs that are seriously scratched or poor manufacturing or recording quality, it may not play.
2. If the player can not read disc under normal condition, please try to eject and reload the disc again.

3. Remark:

- 1) In addition to normal CD and DVD, this unit supports to play CD-R, CD-R/W, DVD-R and DVD-R/W as well; however, depending on the conditions of the recording equipment, recording program or the disc itself, some CD-R, CD-R/W, DVD-R or DVD-R/W may not play.
- 2) When dealing with CD-R, CD-R/W, DVD-R or DVD-R/W recording, too high recording speed may result in poor signal quality and therefore, it is recommendable to select as lower as possible recording speed.

4.2 Pause Playback

When playing DVD/VCD/CD/MP4/MP3/WMA discs, press **PLAY/PAUSE** ►|| button on the front panel or remote control to pause the playback, press **PLAY/PAUSE** ►|| button again to resume normal playback.

4.3 Stop Playback

When playing DVD/VCD/MP3/WMA/CD discs, press **STOP** button once to pause the playback, then press the **PLAY** button to resume the normal playback; press **STOP** button twice to stop the playback, then press **PLAY/PAUSE** ►|| button to start playback from the beginning of the first chapter/track.

4.4 Select Chapter/Track with the ◀◀ or ▶▶ button or |◀◀ / ▶▶| Button

Press ◀◀ or ▶▶ button on the front panel or |◀◀ / ▶▶| Button on the remote control during playback to select the previous or next chapter/track to playback.

Note: Press ◀◀ or ▶▶ button or press |◀◀ / ▶▶| Button multiple times to advance multiple chapters/tracks backward or forward .

4.5 Select Chapter/Track with the Number Buttons

When playing DVD/VCD(PBC OFF)/MP3/WMA/CD discs, press one of the 1~9 and the 0 number buttons to directly select and play the 1st to 9th track / chapter.

If you want to play the track/chapter with serial number bigger than 9, use the 10+, 1~9 and 0 button. For example 1, to play the 13th track/ chapter, firstly press the 10+ button once, then press the 3 button. For example 2, to play the 34th track/chapter, firstly press the 10+ button for 3 times, then press the 4 button.

Note: pressing and holding the +10 or -10 buttons will allow you to move up or down 10 tracks at a time(only for MP3/WMA).

4.6 Select Chapter/Track with the Root/PBC Menu (If the disc includes the root/PBC menu)

When playing DVD discs:

1. Press **TITLE** button on the remote control to display the title list.
2. Press the direction buttons to select your desired title, and then press **OK** or **PLAY/PAUSE** ►|| button to open the root menu of the selected title.
3. Press the direction buttons to select your desired chapter, finally press the **OK** or **PLAY/PAUSE** ►|| button to play the selected chapter. During playback, pressing **TITLE** button on front panel or long pressing **TITLE** button on the remote can directly display the root menu of the title that is playing.

In VCD mode

1. When starting to turn on the PBC function, it will play from the beginning of the disc till it display the PBC menu on TV screen if the disc include the PBC menu.
2. Press the number buttons to select your desired track to play.

In MP3/WMA mode

1. The root menu is displayed on the monitor screen all the time(and the **TITLE/PBC** button is not available).
2. Press the direction buttons to select your desired FOLDER, then press **OK** or **PLAY/PAUSE** ►|| button to open the FOLDER, and then press the direction buttons to select your desired file, finally press **OK** button to play the selected file.

In CD mode, the **TITLE/PBC** button is disabled.

4.7 Terminate the Playback

1. Press **EJECT** button to eject disc.
2. Press and hold **POWER** button on the front panel or briefly press **POWER** button on the remote control to turn off the Stereo.

5. Advanced Disc. USB Operation

5.1 Playback with Speed

During normal playback, Press and hold ◀◀ or ▶▶ button on the front panel repeatedly or press and hold |◀◀ / ▶▶| button on the remote control repeatedly to fast backwards or forwards at the following speeds: x2, x4, x8, x20, normal.

During speed playback, press **PLAY/PAUSE** ►|| button to resume normal playback.

5.2 Playback with Slow Speed

During playback , press **SLOW_FWD** button on the remote control to execute the Slow Forward function.

With each consecutive pressing of **SLOW_FWD** button, the playback speed decreases. The speed levels in Slow Forward as follows: x1/2,,x1/3,x1/4,x1/5,x1/6,1/7,normal.